

# D-SUB GENDER CHANGER/ADAPTOR

DGC Series

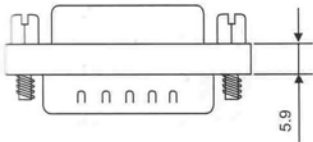

MINI TYPE

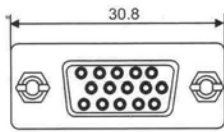
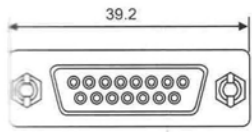

HIGH DENSITY MINI TYPE

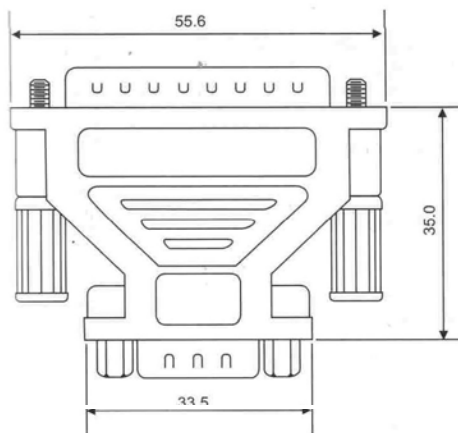
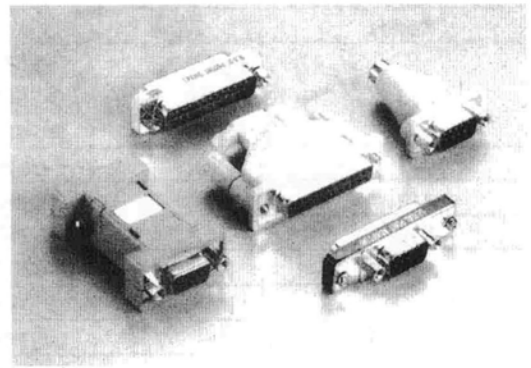

MOLDED TYPE

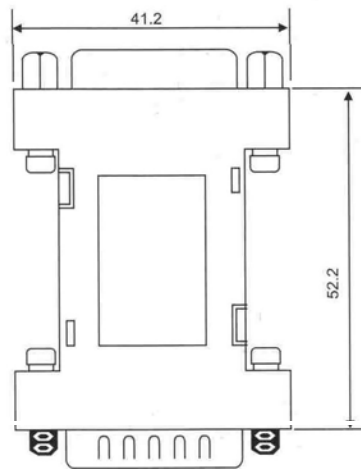

ASSEMBLY TYPE

## Order Information

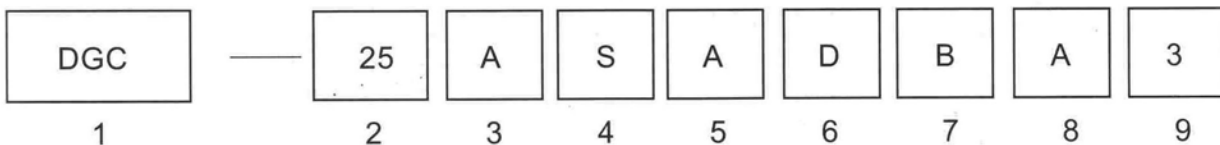

**1.SERIES NO .**  
DGC

**2.CONTACT NUMBER**  
09=09/09  
15=15/15  
25=25/25  
37=37/37  
00=09/25  
01=HDD15/HDD15

**3.CONTACT TYPE**  
A=M/M  
B=M/F  
C=F/F

**4.CONTACT PLATING**  
S=SELECTIVE GOLD  
G=GOLD FLASH

A=5 μ "GOLD  
B=10 μ "GOLD  
C=15 μ "GOLD  
D=30 μ "GOLD

**5.TYPE OPTION**  
A=MINI TYPE  
B=ASSEMBLY TYPE  
C=MOLDED TYPE  
D=D-SUB H.D. MINI TYPE

**6.LABEL/COVER OPTION**  
D=YELLOW LABEL  
E=W/O YELLOW LABEL  
F=METALIZED COVER  
G=METAL COVER  
H=PLASTIC COVER

**7.PARTS OPTION**  
A=LONG SCREWS  
B=SHORT SCREWS

**8.D-SUB INDICATION COLOR**  
A=BLUE  
B=BLACK

**9.COVER COLOR.**  
3=BLACK  
4=GREY  
5=BEIGE  
0=MINI TYPE

# D-SUB GENDER CHANGER/ADAPTOR

Series	Type	Connector Type	Description
810	P/P	D-25P/D-25P	RS-232 Gender Changer
	P/S	D-25P/D-25S	
	S/S	D-25P/D-25S	
811	P/S	D-25P/D-25S	RS-232 Mini Tester (Dual Color LED
812	P/S	D-25P/D-25S	Jumper Box
813	P/S	D-25P/D-25S	Surge Protector
814	P/S	D-25P/D-25S	RS-232 Mini Wiring Box
815	P/P	D-37P/D-37P	37 Pin Gender Changer
	P/S	D-37P/D-37S	
	P/S	D-37P/D-37S	
816	P/P	57S-1036/57S-1036	Centronic Adaptor
	P/S	57S-1036/57S-1036	
	S/S	57S-1036/57S-1036	
817	P/P	D-25P/D-25P	Full Hand Shake Null Modem
	P/S	D-25P/D-25S	
	S/S	D-25P/D-25S	
818	S/P	D-09S/D-25P	AT Modem Adaptor
819	P/S	D-09P/D-25S	Mouse Adaptor
820	P/P	D-09P/D-09P	9 Pin Gender Changer
	P/S	D-09P/D-25S	
	S/S	D-09P/D-25S	
821	P/P	D-15P/D-15P	15 Pin Gender Changer
	P/S	D-15P/D-15S	
	S/S	D-15P/D-15S	
822	P/P	D-25P/57S-1036	IBM Printer Adaptor
	P/S	D-25P/57S-4036	
	S/S	D-25P/57S-4036	
823	S/P	D-09S/DBH-15P	CGA/VGA Monitor Adaptor
824	P/S	57S-1050/57S-4050	SCSI Terminator
	P	57S-1050	
825	P/P	57S-1050/57S-1050	SCSI Gender Changer
	P/S	57S-1050/57S-4050	
	S/S	57S-1050/57S-4050	
826	P/S	D-25P/57S-40360	IBM PS/II Data Migration Adaptor
827	P/P	8300-6P/8100-5P	IBM PS/II Keyboard Adaptor
828	P/P	D-09,15,25,37 57-14,24,36,50	Mini Gender Changer
	P/S		
	S/S		

## Order Information

Series No .                      Mode                      Type                      Connection type

810                      A                      P/S                      (W)

Note: 1. Mode - A: Assembly, M:Molding  
 2.Type- P/P:Male/Male  
       P/S:Male/Female  
       S/S:Female/Female

3. Inner Connection type - W: Wiring,P:PCB

4. For Assembly Mode if the hood need plated type, put (AC) at Mode Code,

5. For 827 Series, available for Straight (S) type, or right angle (R) type ,put code at end of P/N.

6. Special design model is welcome.

7. 828 Series available for D-sub 9,15,25,37 types, & Centronic 14, 24,36,50 pin types,put pin nos. required at Type Code.

